

DIRECTION OF ROTATION

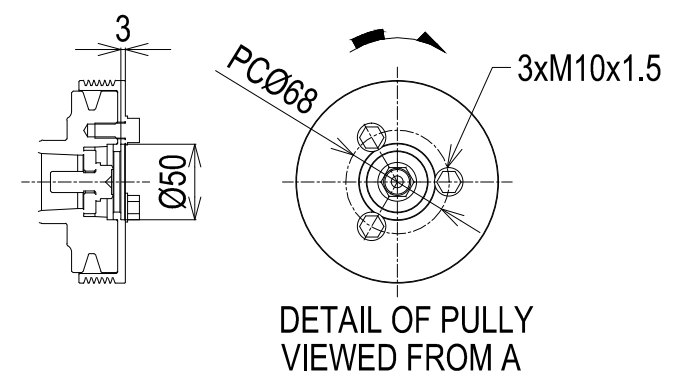

DETAIL OF MOUNTING BLOCK

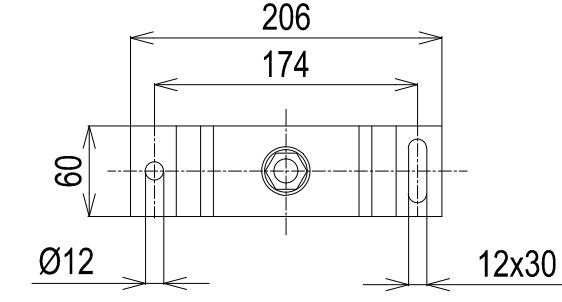

NOTE:

1. DWG. SHOWS MOUNTING BLOCKS AT ORIGINAL HEIGHT. ENGINE WEIGHT WILL COMPRESS BLOCKS BY 4MM (APPROX).
2. MOUNTING BLOCKS ARE EQUIPPED FOR STANDARD ACCESSORY.
3. ● SHOWS THE CENTER OF GRAVITY.
4. THE FIGURES MARKED WITH * SHOW THE DIMENSIONS WITH U-MIXING ELBOW, OR OPTIONAL COUPLING.
5. FOR ADDITIONAL INSTALLATION INFORMATION AND SPECIFICATIONS PLEASE REFER TO THE YANMAR ENGINE INSTALLATION MANUAL

Engine: 4JH5CE_SD60	Release: 26-12-2012
Scale: 1:10	Date: 01-06-2013
	Dimensions: mm